

Slimlok III Wall Frame

Installation Instructions

Suggest 2 persons to fit large frames

Poster Changing Instructions

1

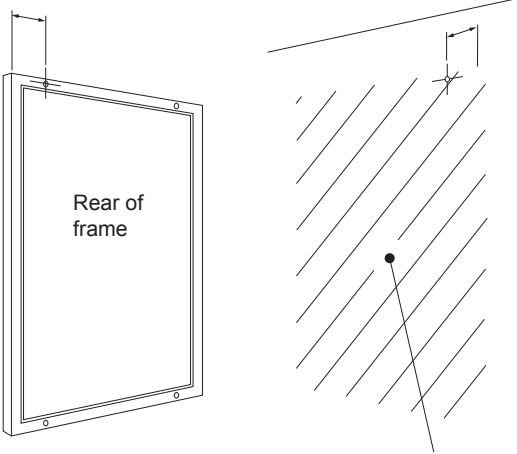

Rear of frame

Select your desired area for the frame. Position the first fixing point to match the hole in the rear of the frame nearest to the lock.

2

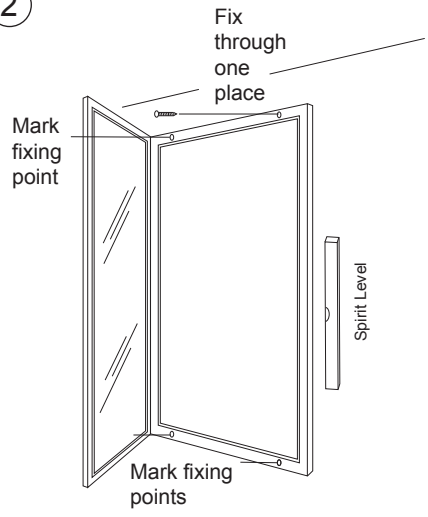

Fix through one place

Mark fixing point

Mark fixing points

Spirit Level

Unlock, open the door & fit one screw. Level the frame & mark the three remaining fixing points.

1

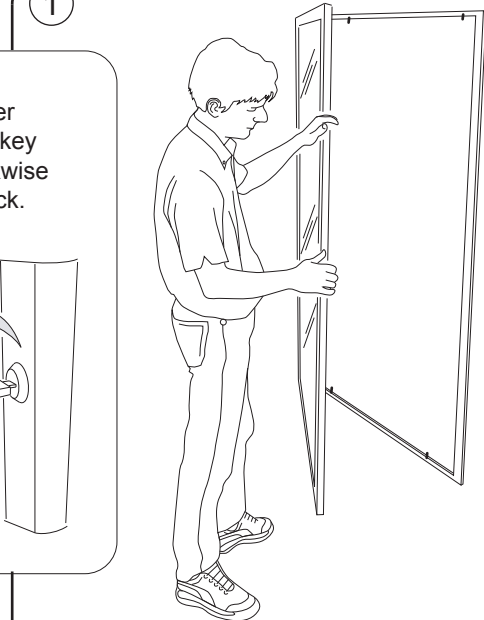

Quarter turn the key anti-clockwise to unlock.

Unlock & open the door. Lock out the stays top & bottom. (If fitted).

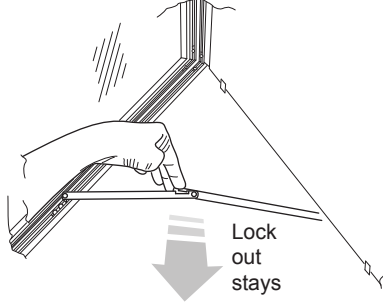

Lock out stays

3

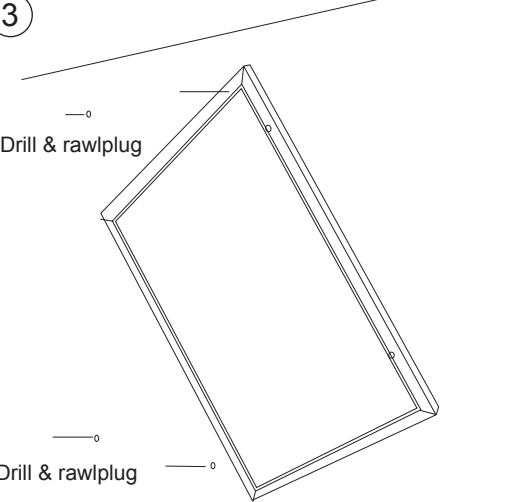

Drill & rawplug

Drill & rawplug

Shut the door & allow the frame to rotate at the fixed point. Drill & rawplug as necessary, where previously marked. Do not attempt to drill the wall through the frame.

4

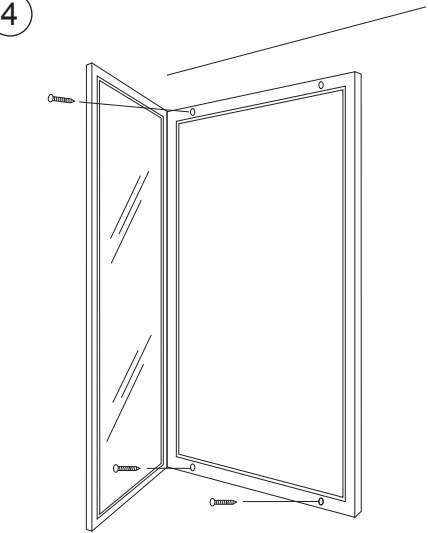

Open the door & fit the frame through the three remaining fixing points.

2

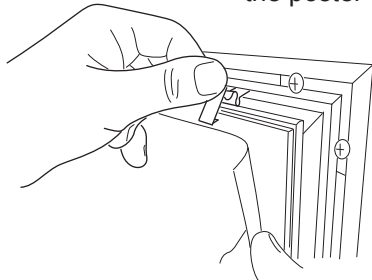

Position the poster under the poster clips.

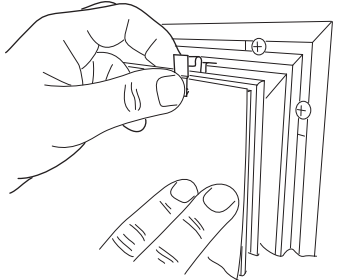

3

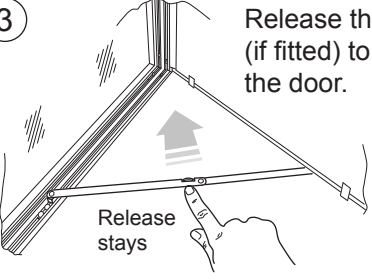

Release the stays (if fitted) to close the door.

Release stays

4



Quarter turn the key clockwise to lock.