

iPad 360

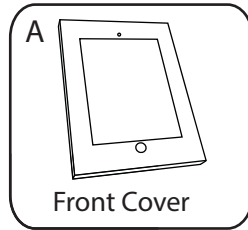

Front Cover

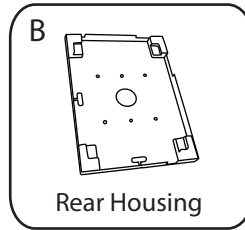

Rear Housing

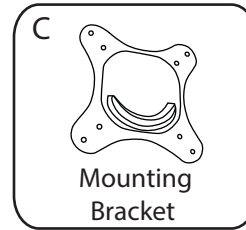

Mounting Bracket

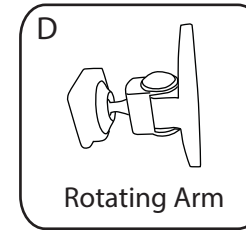

Rotating Arm

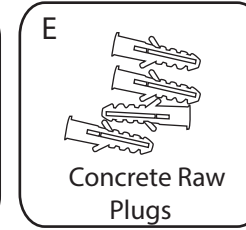

Concrete Raw Plugs

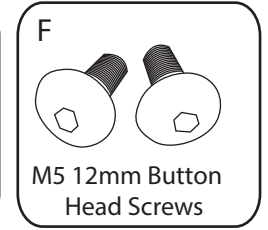

M5 12mm Button Head Screws

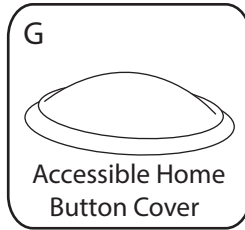

Accessible Home Button Cover

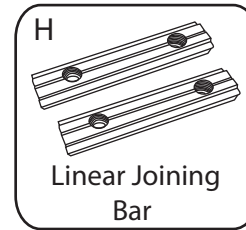

Linear Joining Bar

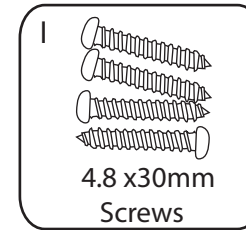

4.8 x30mm Screws

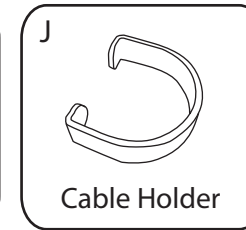

Cable Holder



M4 x 16mm Socket Head Cap Screws

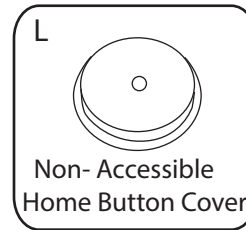

Non-Accessible Home Button Cover

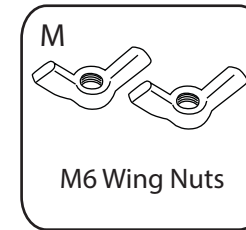

M6 Wing Nuts

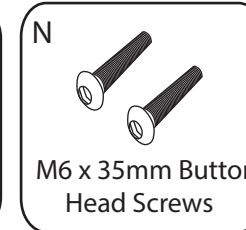

M6 x 35mm Button Head Screws

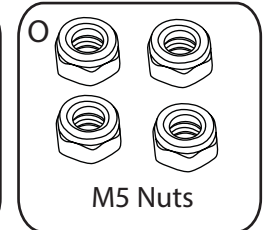

M5 Nuts

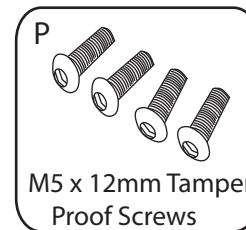

M5 x 12mm Tamper Proof Screws

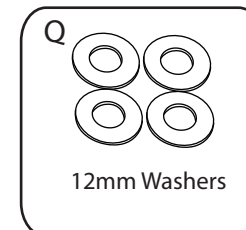

12mm Washers

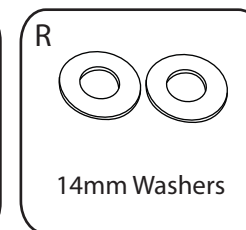

14mm Washers



M5 x 8mm Tamper Proof Screws

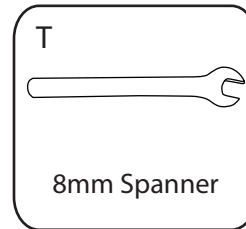

8mm Spanner

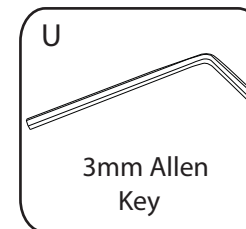

3mm Allen Key

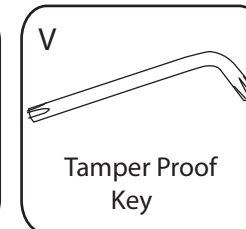

Tamper Proof Key

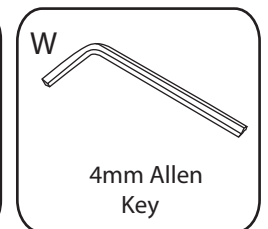

4mm Allen Key



iPad 360

Swivel Bracket Assembly

Parts required D,C,K,U,B,P,O,Q,T,V

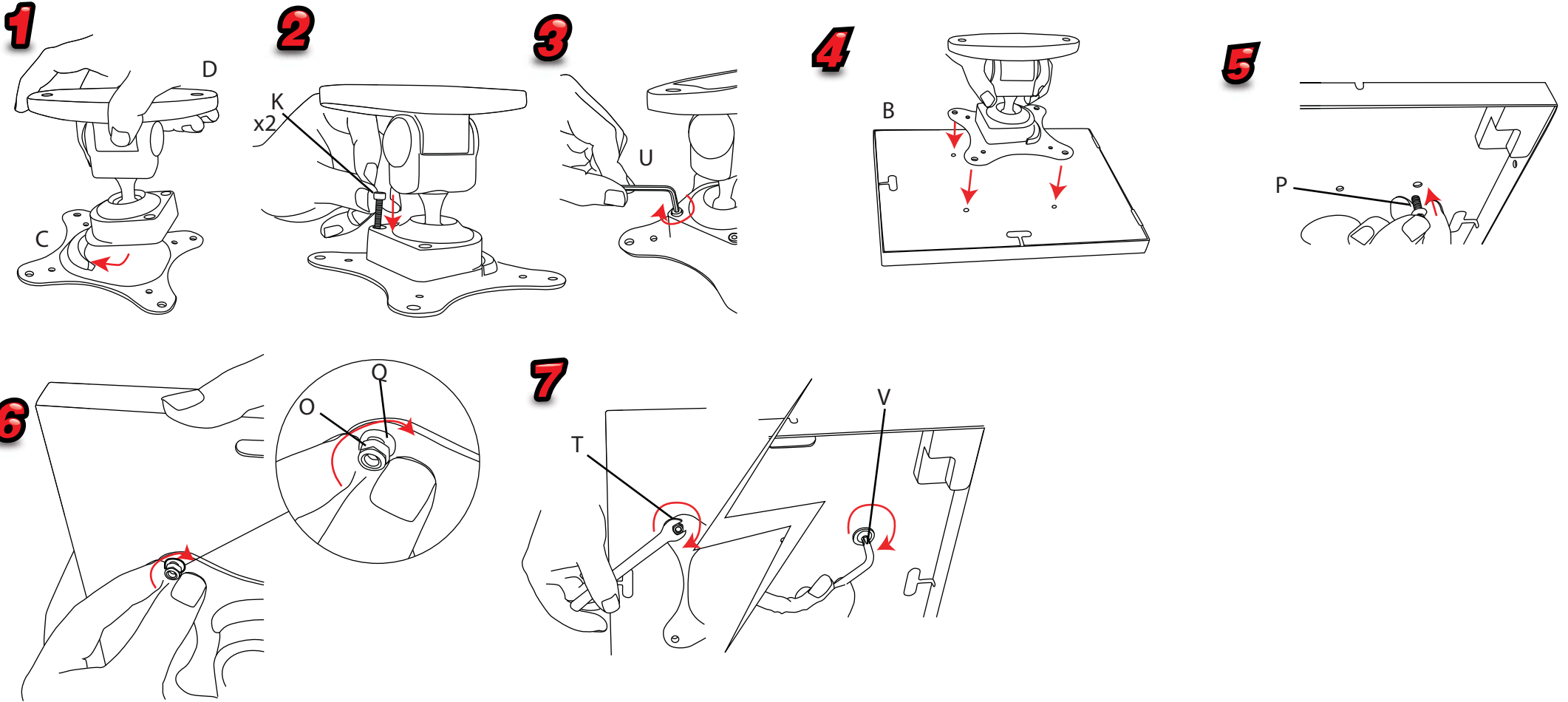

iPad 360

iPad housing Assembly
Parts required B,L,G,A,S,V

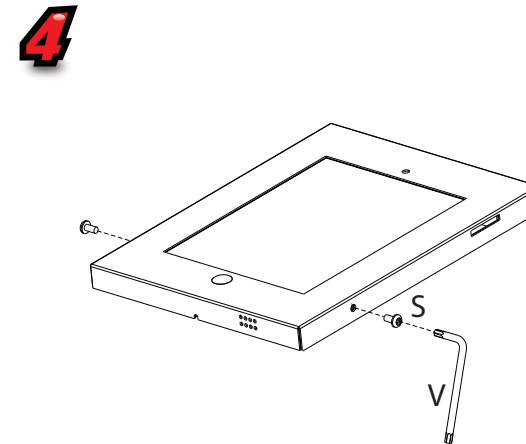
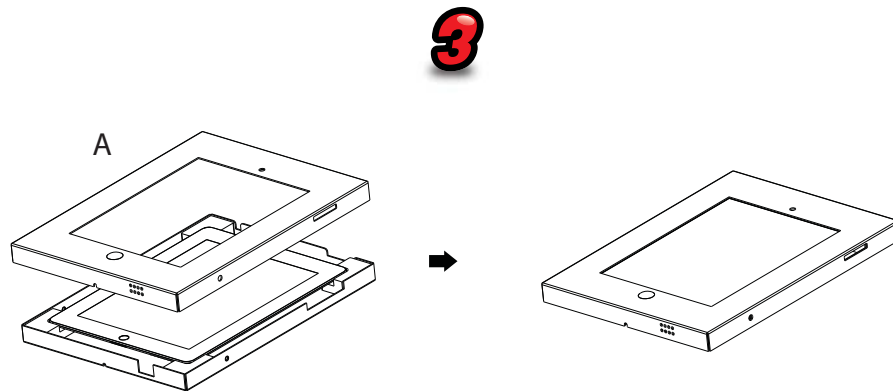
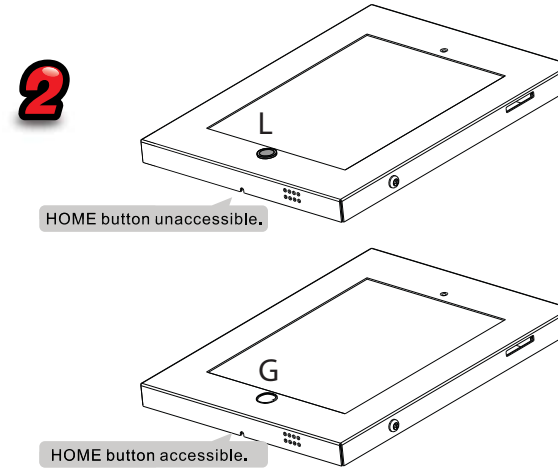
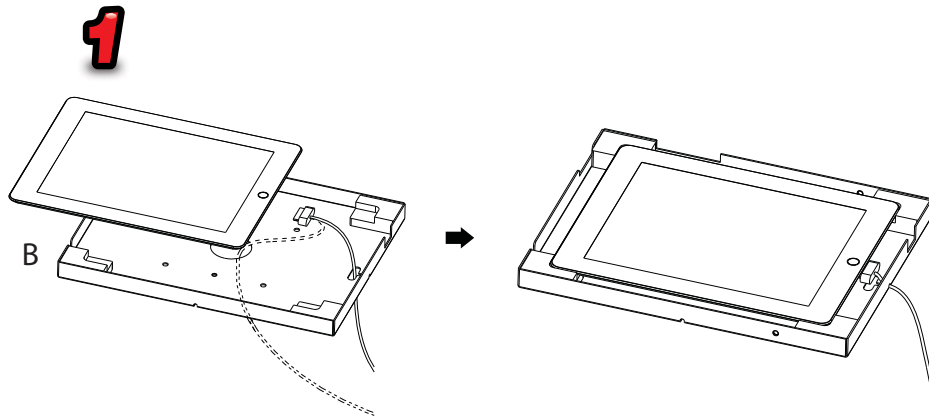

iPad 360

Desktop Mount Assembly
Parts required N,R,W,M

Desktop Mount Hole Dimensions

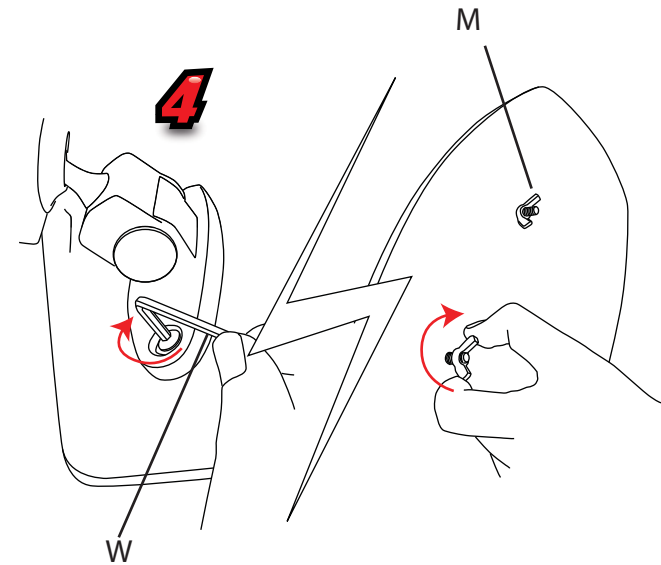
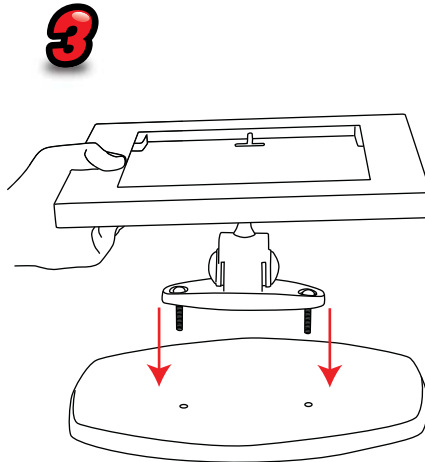
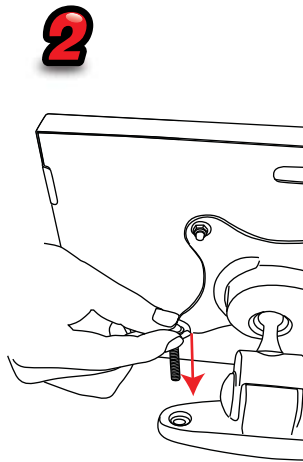
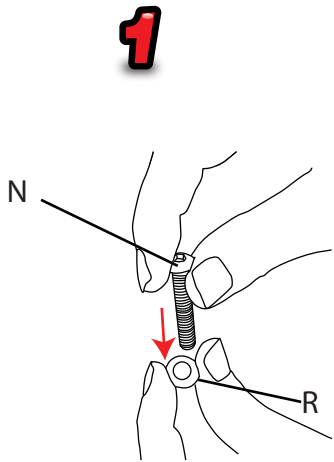
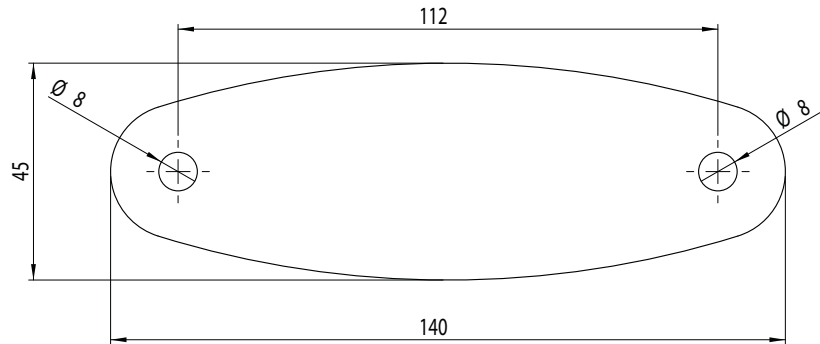

iPad 360

Linear Post Mount Assembly
Parts required F,H,U,B,R

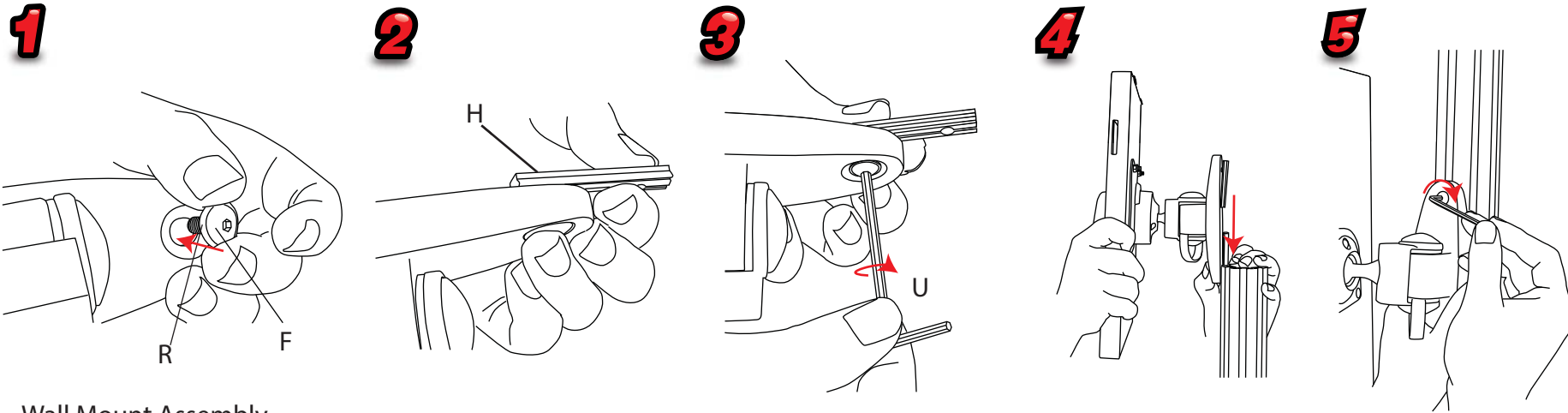

Wall Mount Assembly
Parts required B,E,I

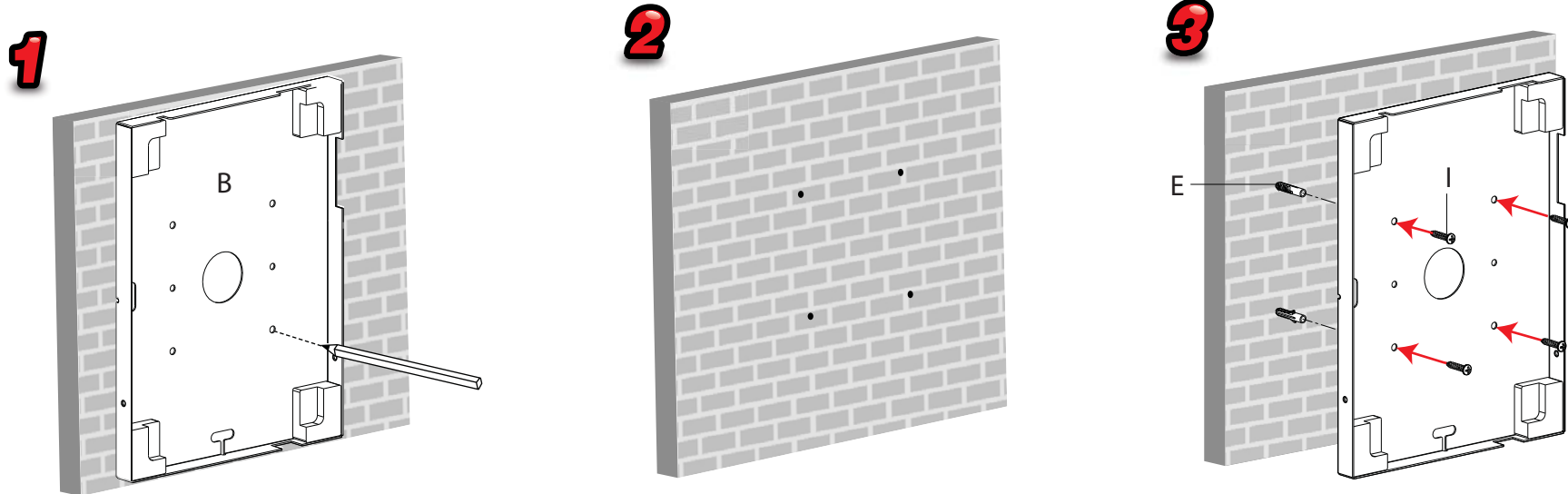

iPad 360

iPad Air pad fittings.

1

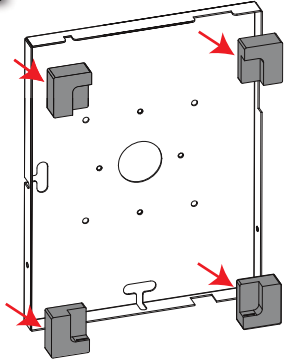

2

